

**Designazione / Designation / Désignation /  
Bezeichnung / Designación / 名称**

PC	71	NMRV	050	120	120x14	25	BS	B3
	063		040				AS	
	071		050				BS	
	080		063				VS	
	090		075				PS	
			090					
			105					
			110					
			130					

Precoppia di riduzione  
Pre-stage helical module  
Précouple de réduction  
Übersetzungsvorstufe  
Pre-reducción  
前置级螺旋模块

Grandezza  
Size  
Grandeur  
Baugröße  
Tamaño  
规格

Tipo riduttore  
Gearbox type  
Type du réducteur  
Getriebetyp  
Tipo reductor  
齿轮箱类型

Motoriduttore a vite senza fine PAM  
Worm geared motor  
Motorréducteur à vis sans fin  
Schneckengetriebemotor  
Motorreductor de tornillo sin fin  
蜗轮蜗杆电机

Grandezza  
Size  
Grandeur  
Baugröße  
Tamaño  
规格

Rapporto di riduzione  
Reduction ratio  
Rapport de réduction  
Übersetzungsverhältnis  
Relación de reducción  
减速比

Dimensioni entrata NMRV  
NMRV input dimensions  
Dimensions d'entrée NMRV  
Abmessungen antriebsseitig NMRV  
Dimensiones entrada NMRV  
输入尺寸 NMRV

Posizione di piazzamento  
Mounting position  
Position de montage  
Einbaulage  
Posición de montaje  
安装位置

Esecuzione  
Execution  
Exécution  
Paarungsform  
Ejecución  
执行

Ø Albero uscita  
Ø Output shaft  
Ø Arbre de sortie  
Ø Abtriebswelle  
Ø Eje de salida  
Ø 输出轴

**PC+NMRV - Esecuzione / Execution / Exécution / Paarungsform / Ejecución / 执行**

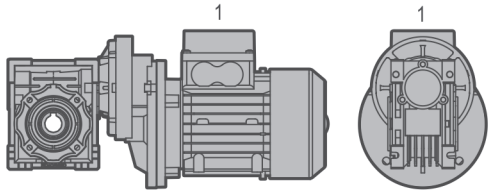
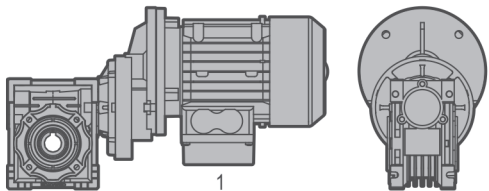
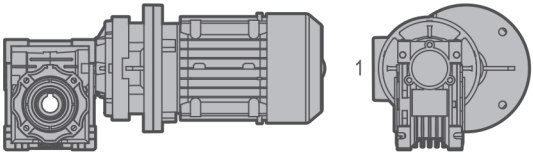
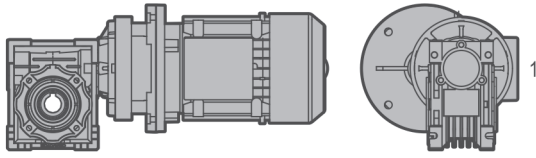
<b>PC - NMRV</b>	
<b>BS</b>	<b>AS</b>
	
<b>VS</b>	<b>PS</b>
	

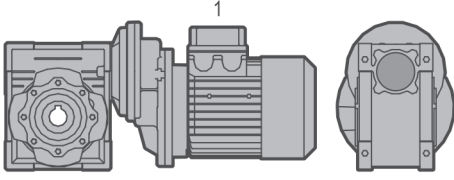
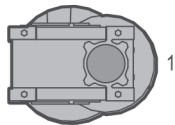
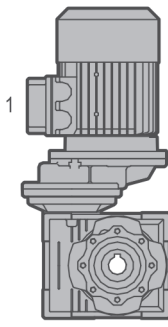
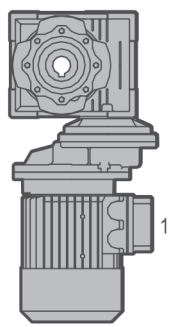
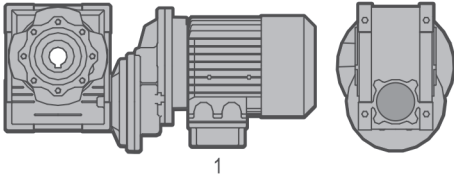
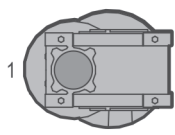

- Se non diversamente specificato le posizioni standard sono BS/B3.
- Unless specified otherwise, the standard positions are BS/B3.
- Si non spécifié, les positions standard sont BS/B3.
- Falls nicht anders angegeben, sind BS/B3 die Standardeinbautagen.
- Si no se especifica el contrario, las posiciones estándar son BS/B3.
- 除非另有其它规定，BS/B3 是标准位置。
  
- N.B.: In fase d'ordine occorre sempre specificare l'esecuzione ed il piazzamento.
- N.B.: When ordering, please always specify execution and mounting position.
- N.B.: Nous vous prions de toujours spécifier sur vos commandes, l'exécution et la position de montage.
- N.B.: Bei Auftragserteilung bitten wir um die Paarungsform und Einbaulage immer genau anzugeben.
- N.B.: En cada pedido especificar siempre la versión y la posición de montaje.
- 注：订货时，务必指明执行位置和安装位置。

**PC+NMRV - Piazzamento / Mounting positions / Pos. de montage / Einbaulage / Pos. de montaje / 安装位置**



<b>PC - NMRV</b>			
<b>B3</b>	<b>B6</b>	<b>V5</b>	<b>V6</b>
			
			

- Per NMRV 030-075 il piazzamento è U e vale per le posizioni B3-B6-B7-B8-V5-V6.
- For NMRV 030-075 mounting position is U and it is valid for positions B3-B6-B7-B8-V5-V6.
- Pour NMRV 030-075 la position de montage est U et est valable aussi pour les positions B3-B6-B7-B8-V5-V6.
- Auf NMRV 030-075 ist die Einbaulage U und sie ist gültig für Einbaulagen B3-B6-B7-B8-V5-V6.
- Para NMRV 030-075 la posición de montaje es U y es válida para las posiciones B3-B6-B7-B8-V5-V6.
- 对于NMRV 030-075,安装位置是 U, 且对 B3-B6-B7-B8-V5-V6 等位置均有效。
  
- Per NMRV 090-105 il piazzamento B3 vale anche per B6-B7-B8. Piazzamenti V5 e V6 sono singoli.
- For NMRV 090-105 mounting position B3 is valid also for B6-B7-B8. Mounting positions V5 and V6 must be specified.
- Pour NMRV 090-105 la position de montage B3 est valable aussi pour les positions B6-B7-B8. Les positions de montage V5 et V6 doivent être spécifiées.
- Auf NMRV 090-105 ist die Einbaulage B3 gültig auch für B6-B7-B8. Einbaulagen V5 und V6 müssen genau angegeben sein.
- Para NMRV090-105 la posición de montaje B3 es válida también para las posiciones B6-B7-B8. Las posiciones de montaje V5-V6 tienen que ser especificadas.
- 对于 NMRV090-105, 安装位置是B3 也对 B6-B7-B8 有效。 必须规定安装位置 V5 和V6。
  
- Per NMRV 110-150 i piazzamenti B3-B6-B7-B8-V5-V6 sono singoli.
- For NMRV 110-150 mounting positions B3-B6-B7-B8-V5-V6 must be specified.
- Pour NMRV 110-150 les positions de montage B3-B6-B7-B8-V5-V6 doivent être spécifiées.
- Auf NMRV 110-150 müssen die Einbaulagen B3-B6-B7-B8-V5-V6 genau angegeben sein.
- Para NMRV110-150 las posiciones de montaje B3-B6-B7-B8-V5-V6 tienen que ser especificadas.
- 对于 NMRV110-150, 必须规定 B3-B6-B7-B8-V5-V6 等安装位置。



## 0,09 kW

n2 [1/min]	M2 [Nm]	f.s.	i			Fr [N]
70,0	8	1,7	40	NMRV030	56A2	948
56,0	10	1,3	50	NMRV030	56A2	1021
46,7	11	1,1	60	NMRV030	56A2	1085
35,0	13	0,8	80	NMRV030	56A2	1194
280,0	3	7,1	5	NMRV030	56B4	597
186,7	4	4,9	7,5	NMRV030	56B4	683
140,0	5	3,7	10	NMRV030	56B4	752
93,3	7	2,6	15	NMRV030	56B4	861
70,0	9	2,0	20	NMRV030	56B4	948
56,0	11	2,1	25	NMRV030	56B4	1021
46,7	12	1,7	30	NMRV030	56B4	1085
35,0	15	1,3	40	NMRV030	56B4	1194
28,0	17	1,0	50	NMRV030	56B4	1286
23,3	19	0,8	60	NMRV030	56B4	1367
180,0	4	5,2	5	NMRV030	63A6	692
120,0	6	3,5	7,5	NMRV030	63A6	792
90,0	8	2,7	10	NMRV030	63A6	871
60,0	11	2,0	15	NMRV030	63A6	997
45,0	14	1,5	20	NMRV030	63A6	1098
36,0	16	1,5	25	NMRV030	63A6	1183
30,0	18	1,2	30	NMRV030	63A6	1257
22,5	21	1,0	40	NMRV030	63A6	1383
18,0	25	0,8	50	NMRV030	63A6	1490
28,0	20	1,6	100	NMRV025/030	56A2	1286
18,7	25	1,1	150	NMRV025/030	56A2	1472
14,0	33	0,9	200	NMRV025/030	56A2	1620
14,0	38	0,8	100	NMRV025/030	56B4	1620
9,3	49	0,6	150	NMRV025/030	56B4	1830
7,0	62	0,5	200	NMRV025/030	56B4	1830
5,6	66	0,5	250	NMRV025/030	56B4	1830
4,7	75	0,4	300	NMRV025/030	56B4	1830
3,5	107	0,3	400	NMRV025/030	56B4	1830
2,8	115	0,3	500	NMRV025/030	56B4	1830
2,3	135	0,2	600	NMRV025/030	56B4	1830
1,9	151	0,2	750	NMRV025/030	56B4	1830
1,6	178	0,2	900	NMRV025/030	56B4	1830
1,2	212	0,1	1200	NMRV025/030	56B4	1830
0,9	247	0,1	1500	NMRV025/030	56B4	1830
0,78	304	0,1	1800	NMRV025/030	56B4	1830
0,58	340	0,1	2400	NMRV025/030	56B4	1830
0,47	405	0,1	3000	NMRV025/030	56B4	1830
28,0	19	2,2	50	NMRV040	56B4	2475
23,3	22	1,8	60	NMRV040	56B4	2630
17,5	26	1,3	80	NMRV040	56B4	2895
14,0	29	1,0	100	NMRV040	56B4	3118
30,0	19	2,8	30	NMRV040	63A6	2419
22,5	24	2,1	40	NMRV040	63A6	2662
18,0	28	1,7	50	NMRV040	63A6	2868
15,0	32	1,3	60	NMRV040	63A6	3047
11,3	37	0,9	80	NMRV040	63A6	3354
9,0	42	0,8	100	NMRV040	63A6	3490
12,0	47	1,3	75	PC063+NMRV040	63A6	3283
10,0	51	1,4	90	PC063+NMRV040	63A6	3488
7,5	62	1,1	120	PC063+NMRV040	63A6	3490
6,0	72	0,8	150	PC063+NMRV040	63A6	3490
5,0	79	0,7	180	PC063+NMRV040	63A6	3490
9,3	45	1,6	300	NMRV025/040	56A2	3490
7,0	54	1,2	400	NMRV025/040	56A2	3490



## 0,09 kW

n2 [1/min]	M2 [Nm]	f.s.	i			Fr [N]
5,6	77	0,8	500	NMRV025/040	56A2	3490
4,7	90	0,8	300	NMRV030/040	56B4	3490
15,0	32	2,4	60	NMRV050	63A6	4183
11,3	38	1,8	80	NMRV050	63A6	4604
9,0	43	1,3	100	NMRV050	63A6	4840
6,0	73	1,6	150	PC063+NMRV050	63A6	4840
5,0	81	1,3	180	PC063+NMRV050	63A6	4840
3,8	94	0,9	240	PC063+NMRV050	63A6	4840
3,0	106	0,7	300	PC063+NMRV050	63A6	4840
3,5	110	1,1	400	NMRV030/050	56B4	4840
2,8	127	0,9	500	NMRV030/050	56B4	4840
2,3	164	0,9	600	NMRV030/050	56B4	4840
1,9	191	0,8	750	NMRV030/050	56B4	4840
1,6	219	0,7	900	NMRV030/050	56B4	4840
3,8	99	1,7	240	PC063+NMRV063	63A6	6270
3,0	109	1,4	300	PC063+NMRV063	63A6	6270
1,6	207	1,0	900	NMRV030/063	56B4	6270
1,2	272	0,8	1200	NMRV030/063	56B4	6270
0,93	316	0,7	1500	NMRV030/063	56B4	6270
0,93	371	1,1	1500	NMRV040/075	56B4	7380
0,78	417	0,9	1800	NMRV040/075	56B4	7380
0,58	513	0,7	2400	NMRV040/075	56B4	7380
0,47	630	0,9	3000	NMRV040/090	56B4	8180
0,35	758	0,6	4000	NMRV040/090	56B4	8180



## 0,12 kW

n2 [1/min]	M2 [Nm]	f.s.	i			Fr [N]
560,0	2	4,4	5	NMRV025	56B2	349
373,3	3	3,0	7,5	NMRV025	56B2	399
280,0	4	2,6	10	NMRV025	56B2	439
186,7	5	1,8	15	NMRV025	56B2	503
140,0	6	1,4	20	NMRV025	56B2	553
93,3	9	1,0	30	NMRV025	56B2	633
70,0	11	0,8	40	NMRV025	56B2	697
280,0	4	5,3	5	NMRV030	63A4	597
186,7	5	3,6	7,5	NMRV030	63A4	683
140,0	7	2,8	10	NMRV030	63A4	752
93,3	10	2,0	15	NMRV030	63A4	861
70,0	12	1,5	20	NMRV030	63A4	948
56,0	14	1,6	25	NMRV030	63A4	1021
46,7	16	1,3	30	NMRV030	63A4	1085
35,0	20	1,0	40	NMRV030	63A4	1194
28,0	23	0,8	50	NMRV030	63A4	1286
180,0	5	3,9	5	NMRV030	63B6	692
120,0	8	2,6	7,5	NMRV030	63B6	792
90,0	10	2,0	10	NMRV030	63B6	871
60,0	14	1,5	15	NMRV030	63B6	997
45,0	18	1,1	20	NMRV030	63B6	1098
36,0	21	1,2	25	NMRV030	63B6	1183
30,0	24	0,9	30	NMRV030	63B6	1257
46,7	17	2,8	30	NMRV040	63A4	2087
35,0	22	2,1	40	NMRV040	63A4	2298
28,0	26	1,6	50	NMRV040	63A4	2475
23,3	29	1,3	60	NMRV040	63A4	2630
17,5	35	1,0	80	NMRV040	63A4	2895



## 0,12 kW

n2 [1/min]	M2 [Nm]	f.s.	i			Fr [N]
14,0	39	0,7	100	NMRV040	63A4	3118
30,0	26	2,1	30	NMRV040	63B6	2419
22,5	32	1,6	40	NMRV040	63B6	2662
18,0	37	1,2	50	NMRV040	63B6	2868
15,0	42	1,0	60	NMRV040	63B6	3047
18,7	42	1,2	75	PC063+NMRV040	63A4	2833
15,6	46	1,2	90	PC063+NMRV040	63A4	3011
11,7	57	0,9	120	PC063+NMRV040	63A4	3314
9,3	66	0,7	150	PC063+NMRV040	63A4	3490
7,8	74	0,6	180	PC063+NMRV040	63A4	3490
12,0	62	1,0	75	PC063+NMRV040	63B6	3283
10,0	68	1,1	90	PC063+NMRV040	63B6	3488
7,5	83	0,8	120	PC063+NMRV040	63B6	3490
23,3	29	2,4	60	NMRV050	63A4	3610
17,5	35	1,8	80	NMRV050	63A4	3973
14,0	41	1,3	100	NMRV050	63A4	4280
22,5	33	2,7	40	NMRV050	63B6	3654
18,0	38	2,1	50	NMRV050	63B6	3936
15,0	43	1,8	60	NMRV050	63B6	4183
11,3	51	1,3	80	NMRV050	63B6	4604
9,0	57	1,0	100	NMRV050	63B6	4840
9,3	68	1,3	150	PC063+NMRV050	63A4	4840
7,8	75	1,1	180	PC063+NMRV050	63A4	4840
5,8	88	0,8	240	PC063+NMRV050	63A4	4840
4,7	98	0,7	300	PC063+NMRV050	63A4	4840
12,0	63	1,7	75	PC063+NMRV050	63B6	4506
10,0	70	2,1	90	PC063+NMRV050	63B6	4788
7,5	84	1,5	120	PC063+NMRV050	63B6	4840
6,0	97	1,2	150	PC063+NMRV050	63B6	4840
5,0	108	1,0	180	PC063+NMRV050	63B6	4840
3,8	125	0,7	240	PC063+NMRV050	63B6	4840
4,7	122	1,2	300	NMRV030/050	63A4	4840
3,5	147	0,8	400	NMRV030/050	63A4	4840
2,8	170	0,7	500	NMRV030/050	63A4	4840
5,8	92	1,5	240	PC063+NMRV063	63A4	6270
4,7	103	1,2	300	PC063+NMRV063	63A4	6270
6,0	101	2,1	150	PC063+NMRV063	63B6	6270
5,0	112	1,8	180	PC063+NMRV063	63B6	6270
3,8	131	1,3	240	PC063+NMRV063	63B6	6270
3,0	145	1,0	300	PC063+NMRV063	63B6	6270
2,8	177	1,2	500	NMRV030/063	63A4	6270
2,3	215	1,1	600	NMRV030/063	63A4	6270
1,9	249	0,9	750	NMRV030/063	63A4	6270
1,6	335	1,2	900	NMRV040/075	63A4	7380
1,2	411	0,9	1200	NMRV040/075	63A4	7380
0,78	565	0,9	1800	NMRV040/090	63A4	8180
0,58	719	0,8	2400	NMRV040/090	63A4	8180
0,47	914	1,1	3000	NMRV050/105	63A4	10320
0,35	1111	0,7	4000	NMRV050/105	63A4	10320
0,28	1257	0,6	5000	NMRV050/105	63A4	10320
0,47	914	1,2	3000	NMRV050/110	63A4	10320
0,35	1111	0,7	4000	NMRV050/110	63A4	10320
0,28	1257	0,6	5000	NMRV050/110	63A4	10320



## 0,15 kW

n2 [1/min]	M2 [Nm]	f.s.	i			Fr [N]
180,0	7	3,1	5	NMRV030	63C6	692
120,0	10	2,1	7,5	NMRV030	63C6	792
90,0	13	1,6	10	NMRV030	63C6	871
60,0	18	1,2	15	NMRV030	63C6	997
45,0	23	0,9	20	NMRV030	63C6	1098
60,0	19	2,7	15	NMRV040	63C6	1920
45,0	24	2,0	20	NMRV040	63C6	2113
36,0	29	1,5	25	NMRV040	63C6	2276
30,0	32	1,7	30	NMRV040	63C6	2419
22,5	40	1,2	40	NMRV040	63C6	2662
18,0	46	1,0	50	NMRV040	63C6	2868
18,0	48	1,7	50	NMRV050	63C6	3936
15,0	53	1,4	60	NMRV050	63C6	4183
11,3	64	1,1	80	NMRV050	63C6	4604
10,0	87	1,7	90	PC063+NMRV050	63C6	4788
7,5	105	1,2	120	PC063+NMRV050	63C6	4840
6,0	127	1,7	150	PC063+NMRV063	63C6	6270
5,0	140	1,4	180	PC063+NMRV063	63C6	6270



## 0,18 kW

n2 [1/min]	M2 [Nm]	f.s.	i			Fr [N]
560,0	3	4,4	5	NMRV030	63A2	474
373,3	4	3,2	7,5	NMRV030	63A2	542
280,0	5	2,5	10	NMRV030	63A2	597
186,7	8	1,7	15	NMRV030	63A2	683
140,0	10	1,2	20	NMRV030	63A2	752
112,0	12	1,4	25	NMRV030	63A2	810
93,3	13	1,1	30	NMRV030	63A2	861
70,0	16	0,9	40	NMRV030	63A2	948
280,0	5	3,6	5	NMRV030	63B4	597
186,7	8	2,4	7,5	NMRV030	63B4	683
140,0	10	1,9	10	NMRV030	63B4	752
93,3	14	1,3	15	NMRV030	63B4	861
70,0	18	1,0	20	NMRV030	63B4	948
56,0	21	1,0	25	NMRV030	63B4	1021
46,7	24	0,9	30	NMRV030	63B4	1085
93,3	14	2,4	30	NMRV040	63A2	1657
70,0	18	1,7	40	NMRV040	63A2	1824
56,0	21	1,4	50	NMRV040	63A2	1964
70,0	19	2,2	20	NMRV040	63B4	1824
56,0	23	1,7	25	NMRV040	63B4	1964
46,7	26	1,8	30	NMRV040	63B4	2087
35,0	32	1,4	40	NMRV040	63B4	2298
28,0	39	1,1	50	NMRV040	63B4	2475
23,3	43	0,9	60	NMRV040	63B4	2630
45,0	29	1,7	20	NMRV040	71A6	2113
36,0	35	1,3	25	NMRV040	71A6	2276
30,0	38	1,4	30	NMRV040	71A6	2419
22,5	48	1,0	40	NMRV040	71A6	2662
18,7	64	0,8	75	PC063+NMRV040	63B4	2833
15,6	70	0,8	90	PC063+NMRV040	63B4	3011
11,7	85	0,6	120	PC063+NMRV040	63B4	3314
46,7	25	2,0	60	NMRV050	63A2	2865
35,0	30	1,5	80	NMRV050	63A2	3153
28,0	35	1,1	100	NMRV050	63A2	3397

## 0,18 kW



n2 [1/min]	M2 [Nm]	f.s.	i			Fr [N]
35,0	33	2,5	40	NMRV050	63B4	3153
28,0	39	2,0	50	NMRV050	63B4	3397
23,3	44	1,6	60	NMRV050	63B4	3610
17,5	53	1,2	80	NMRV050	63B4	3973
14,0	61	0,9	100	NMRV050	63B4	4280
18,0	57	1,4	50	NMRV050	71A6	3936
15,0	64	1,2	60	NMRV050	71A6	4183
11,3	76	0,9	80	NMRV050	71A6	4604
18,7	64	1,4	75	PC063+NMRV050	63B4	3889
15,6	71	1,5	90	PC063+NMRV050	63B4	4132
11,7	87	1,1	120	PC063+NMRV050	63B4	4548
9,3	101	0,9	150	PC063+NMRV050	63B4	4840
7,8	113	0,7	180	PC063+NMRV050	63B4	4840
5,8	133	0,6	240	PC063+NMRV050	63B4	4840
12,0	95	1,2	75	PC071+NMRV050	71A6	4506
10,0	105	1,4	90	PC071+NMRV050	71A6	4788
7,5	126	1,0	120	PC071+NMRV050	71A6	4840
15,0	68	2,1	60	NMRV063	71A6	5467
11,3	81	1,6	80	NMRV063	71A6	6018
9,0	92	1,4	100	NMRV063	71A6	6270
9,3	103	1,7	150	PC063+NMRV063	63B4	6270
7,8	117	1,4	180	PC063+NMRV063	63B4	6270
5,8	139	1,0	240	PC063+NMRV063	63B4	6270
4,7	155	0,8	300	PC063+NMRV063	63B4	6270
12,0	97	2,2	75	PC071+NMRV063	71A6	5889
10,0	107	2,4	90	PC071+NMRV063	71A6	6259
7,5	131	1,8	120	PC071+NMRV063	71A6	6270
6,0	152	1,4	150	PC071+NMRV063	71A6	6270
5,0	168	1,2	180	PC071+NMRV063	71A6	6270
3,8	197	0,9	240	PC071+NMRV063	71A6	6270
3,0	218	0,7	300	PC071+NMRV063	71A6	6270
3,5	228	1,0	400	NMRV030/063	63B4	6270
2,8	265	0,8	500	NMRV030/063	63B4	6270
5,0	179	1,7	180	PC071+NMRV075	71A6	7380
3,8	211	1,2	240	PC071+NMRV075	71A6	7380
3,0	235	1,0	300	PC071+NMRV075	71A6	7380
2,3	372	1,0	600	NMRV040/075	63B4	7380
1,9	448	0,9	750	NMRV040/075	63B4	7380
1,6	502	0,8	900	NMRV040/075	63B4	7380
1,2	649	0,9	1200	NMRV040/090	63B4	8180
0,93	758	0,7	1500	NMRV040/090	63B4	8180
0,78	888	1,2	1800	NMRV050/105	63B4	10320
0,58	1149	0,9	2400	NMRV050/105	63B4	10320
0,78	888	1,4	1800	NMRV050/110	63B4	10320
0,58	1149	1,0	2400	NMRV050/110	63B4	10320

## 0,22 kW



n2 [1/min]	M2 [Nm]	f.s.	i			Fr [N]
280,0	7	2,9	5	NMRV030	63C4	597
186,7	10	2,0	7,5	NMRV030	63C4	683
140,0	12	1,5	10	NMRV030	63C4	752
93,3	18	1,1	15	NMRV030	63C4	861
70,0	22	0,8	20	NMRV030	63C4	948
93,3	19	2,4	15	NMRV040	63C4	1657
70,0	24	1,8	20	NMRV040	63C4	1824





## 0,22 kW

n2 [1/min]	M2 [Nm]	f.s.	i			Fr [N]
56,0	29	1,4	25	NMRV040	63C4	1964
46,7	32	1,5	30	NMRV040	63C4	2087
35,0	40	1,1	40	NMRV040	63C4	2298
28,0	47	0,9	50	NMRV040	63C4	2475
28,0	48	1,6	50	NMRV050	63C4	3397
23,3	54	1,3	60	NMRV050	63C4	3610
17,5	65	1,0	80	NMRV050	63C4	3973
18,7	78	1,2	75	PC063+NMRV050	63C4	3889
15,6	86	1,2	90	PC063+NMRV050	63C4	4132
11,7	106	0,9	120	PC063+NMRV050	63C4	4548
9,3	126	1,4	150	PC063+NMRV063	63C4	6270
7,8	143	1,1	180	PC063+NMRV063	63C4	6270
4,7	214	1,1	300	NMRV030/063	63C4	6270
3,5	279	0,8	400	NMRV030/063	63C4	6270



## 0,25 kW

n2 [1/min]	M2 [Nm]	f.s.	i			Fr [N]
560,0	4	3,2	5	NMRV030	63B2	474
373,3	6	2,3	7,5	NMRV030	63B2	542
280,0	7	1,8	10	NMRV030	63B2	597
186,7	10	1,2	15	NMRV030	63B2	683
140,0	13	0,9	20	NMRV030	63B2	752
112,0	16	1,0	25	NMRV030	63B2	810
93,3	18	0,8	30	NMRV030	63B2	861
280,0	8	4,7	5	NMRV040	71A4	1149
186,7	11	3,8	7,5	NMRV040	71A4	1315
140,0	14	3,0	10	NMRV040	71A4	1447
93,3	21	2,1	15	NMRV040	71A4	1657
70,0	27	1,6	20	NMRV040	71A4	1824
56,0	32	1,2	25	NMRV040	71A4	1964
46,7	36	1,3	30	NMRV040	71A4	2087
35,0	45	1,0	40	NMRV040	71A4	2298
180,0	12	3,6	5	NMRV040	71B6	1331
120,0	17	2,7	7,5	NMRV040	71B6	1524
90,0	22	2,2	10	NMRV040	71B6	1677
60,0	31	1,6	15	NMRV040	71B6	1920
45,0	40	1,2	20	NMRV040	71B6	2113
36,0	48	0,9	25	NMRV040	71B6	2276
30,0	53	1,0	30	NMRV040	71B6	2419
35,0	42	1,1	80	NMRV050	63B2	3153
28,0	49	0,8	100	NMRV050	63B2	3397
70,0	27	2,9	20	NMRV050	71A4	2503
56,0	33	2,2	25	NMRV050	71A4	2696
46,7	37	2,4	30	NMRV050	71A4	2865
35,0	46	1,8	40	NMRV050	71A4	3153
28,0	55	1,4	50	NMRV050	71A4	3397
23,3	61	1,2	60	NMRV050	71A4	3610
17,5	74	0,9	80	NMRV050	71A4	3973
45,0	41	2,0	20	NMRV050	71B6	2900
36,0	49	1,5	25	NMRV050	71B6	3124
30,0	55	1,7	30	NMRV050	71B6	3320
22,5	68	1,3	40	NMRV050	71B6	3654
18,0	80	1,0	50	NMRV050	71B6	3936
15,0	89	0,9	60	NMRV050	71B6	4183
18,7	88	1,0	75	PC071+NMRV050	71A4	3889



## 0,25 kW

n2 [1/min]	M2 [Nm]	f.s.	i			Fr [N]
15,6	98	1,1	90	PC071+NMRV050	71A4	4132
11,7	121	0,8	120	PC071+NMRV050	71A4	4548
28,0	57	2,4	50	NMRV063	71A4	4440
23,3	64	2,0	60	NMRV063	71A4	4719
17,5	79	1,5	80	NMRV063	71A4	5193
14,0	89	1,3	100	NMRV063	71A4	5595
18,0	82	1,8	50	NMRV063	71B6	5145
15,0	94	1,5	60	NMRV063	71B6	5467
11,3	112	1,1	80	NMRV063	71B6	6018
9,0	127	1,0	100	NMRV063	71B6	6270
18,7	91	1,8	75	PC071+NMRV063	71A4	5083
15,6	100	2,0	90	PC071+NMRV063	71A4	5401
11,7	125	1,5	120	PC071+NMRV063	71A4	5945
9,3	143	1,2	150	PC071+NMRV063	71A4	6270
7,8	163	1,0	180	PC071+NMRV063	71A4	6270
5,8	192	0,7	240	PC071+NMRV063	71A4	6270
4,7	215	0,6	300	PC071+NMRV063	71A4	6270
12,0	135	1,6	75	PC071+NMRV063	71B6	5889
10,0	148	1,8	90	PC071+NMRV063	71B6	6259
7,5	181	1,3	120	PC071+NMRV063	71B6	6270
6,0	211	1,0	150	PC071+NMRV063	71B6	6270
7,0	159	1,4	400	NMRV030/063	63B2	6270
5,6	185	1,2	500	NMRV030/063	63B2	6270
17,5	83	2,3	80	NMRV075	71A4	6130
14,0	96	1,9	100	NMRV075	71A4	6603
11,3	119	1,7	80	NMRV075	71B6	7103
9,0	135	1,4	100	NMRV075	71B6	7380
9,3	151	1,7	150	PC071+NMRV075	71A4	7380
7,8	172	1,4	180	PC071+NMRV075	71A4	7380
5,8	201	1,1	240	PC071+NMRV075	71A4	7380
4,7	230	0,9	300	PC071+NMRV075	71A4	7380
12,0	139	2,4	75	PC071+NMRV075	71B6	6952
10,0	155	2,5	90	PC071+NMRV075	71B6	7380
7,5	191	1,9	120	PC071+NMRV075	71B6	7380
6,0	219	1,5	150	PC071+NMRV075	71B6	7380
5,0	248	1,2	180	PC071+NMRV075	71B6	7380
3,5	342	1,1	400	NMRV040/075	71A4	7380
2,8	391	0,8	500	NMRV040/075	71A4	7380
5,0	263	1,9	180	PC071+NMRV090	71B6	8180
3,8	318	1,4	240	PC071+NMRV090	71B6	8180
3,0	358	1,1	300	PC071+NMRV090	71B6	8180
2,3	527	1,2	600	NMRV040/090	71A4	8180
1,9	616	0,9	750	NMRV040/090	71A4	8180
1,6	688	0,7	900	NMRV040/090	71A4	8180
1,2	971	1,1	1200	NMRV050/105	71A4	10320
0,93	1097	1,0	1500	NMRV050/105	71A4	10320
0,78	1234	0,9	1800	NMRV050/105	71A4	10320
1,2	971	1,2	1200	NMRV050/110	71A4	10320
0,93	1097	1,2	1500	NMRV050/110	71A4	10320
0,78	1234	1,0	1800	NMRV050/110	71A4	10320
0,58	1676	1,0	2400	NMRV063/130	71A4	13500
0,47	1998	0,8	3000	NMRV063/130	71A4	13500
0,35	2422	0,5	4000	NMRV063/130	71A4	13500
0,28	2742	0,4	5000	NMRV063/130	71A4	13500
0,8	1412	1,5	1800	NMRV063/150	71A4	18000
0,6	1702	1,6	2400	NMRV063/150	71A4	18000
0,5	1998	1,2	3000	NMRV063/150	71A4	18000
0,4	2422	0,8	4000	NMRV063/150	71A4	18000
0,3	2742	0,6	5000	NMRV063/150	71A4	18000



## 0,37 kW

n2 [1/min]	M2 [Nm]	f.s.	i			Fr [N]
560,0	6	2,1	5	NMRV030	63C2	474
373,3	8	1,6	7,5	NMRV030	63C2	542
280,0	11	1,2	10	NMRV030	63C2	597
186,7	16	0,8	15	NMRV030	63C2	683
560,0	6	4,2	5	NMRV040	71A2	912
373,3	8	3,3	7,5	NMRV040	71A2	1044
280,0	11	2,6	10	NMRV040	71A2	1149
186,7	16	1,9	15	NMRV040	71A2	1315
140,0	21	1,4	20	NMRV040	71A2	1447
112,0	25	1,1	25	NMRV040	71A2	1559
280,0	11	3,2	5	NMRV040	71B4	1149
186,7	16	2,6	7,5	NMRV040	71B4	1315
140,0	21	2,1	10	NMRV040	71B4	1447
93,3	31	1,4	15	NMRV040	71B4	1657
70,0	40	1,1	20	NMRV040	71B4	1824
56,0	48	0,8	25	NMRV040	71B4	1964
46,7	54	0,9	30	NMRV040	71B4	2087
112,0	26	2,0	25	NMRV050	71A2	2140
93,3	29	2,2	30	NMRV050	71A2	2274
70,0	37	1,6	40	NMRV050	71A2	2503
56,0	44	1,2	50	NMRV050	71A2	2696
46,7	51	1,0	60	NMRV050	71A2	2865
35,0	63	0,7	80	NMRV050	71A2	3153
140,0	22	3,6	10	NMRV050	71B4	1987
93,3	31	2,6	15	NMRV050	71B4	2274
70,0	40	1,9	20	NMRV050	71B4	2503
56,0	49	1,5	25	NMRV050	71B4	2696
46,7	55	1,6	30	NMRV050	71B4	2865
35,0	69	1,2	40	NMRV050	71B4	3153
28,0	81	1,0	50	NMRV050	71B4	3397
23,3	91	0,8	60	NMRV050	71B4	3610
180,0	17	4,7	5	NMRV050	80A6	1827
120,0	25	3,6	7,5	NMRV050	80A6	2091
90,0	33	2,8	10	NMRV050	80A6	2302
60,0	47	2,0	15	NMRV050	80A6	2635
45,0	60	1,4	20	NMRV050	80A6	2900
36,0	73	1,0	25	NMRV050	80A6	3124
30,0	81	1,2	30	NMRV050	80A6	3320
35,0	72	2,0	40	NMRV063	71B4	4122
28,0	85	1,6	50	NMRV063	71B4	4440
23,3	95	1,4	60	NMRV063	71B4	4719
17,5	117	1,0	80	NMRV063	71B4	5193
14,0	131	0,9	100	NMRV063	71B4	5595
45,0	61	2,4	20	NMRV063	80A6	3791
36,0	75	1,9	25	NMRV063	80A6	4084
30,0	84	2,1	30	NMRV063	80A6	4339
22,5	104	1,5	40	NMRV063	80A6	4776
18,0	122	1,2	50	NMRV063	80A6	5145
15,0	139	1,0	60	NMRV063	80A6	5467
18,7	134	1,2	75	PC071+NMRV063	71B4	5083
15,6	148	1,4	90	PC071+NMRV063	71B4	5401
11,7	185	1,0	120	PC071+NMRV063	71B4	5945
9,3	212	0,8	150	PC071+NMRV063	71B4	6270
9,3	181	1,3	300	NMRV030/063	63C2	6270
7,0	236	1,0	400	NMRV030/063	63C2	6270
23,3	100	2,0	60	NMRV075	71B4	5569
17,5	123	1,5	80	NMRV075	71B4	6130
14,0	141	1,3	100	NMRV075	71B4	6603



## 0,37 kW

n2 [1/min]	M2 [Nm]	f.s.	i			Fr [N]
18,0	128	1,8	50	NMRV075	80A6	6073
15,0	146	1,5	60	NMRV075	80A6	6453
11,3	176	1,1	80	NMRV075	80A6	7103
9,0	200	0,9	100	NMRV075	80A6	7380
18,7	138	1,8	75	PC071+NMRV075	71B4	6000
15,6	154	1,9	90	PC071+NMRV075	71B4	6375
11,7	191	1,5	120	PC071+NMRV075	71B4	7017
9,3	223	1,1	150	PC071+NMRV075	71B4	7380
7,8	254	0,9	180	PC071+NMRV075	71B4	7380
12,0	206	1,6	75	PC080+NMRV075	80A6	6952
10,0	230	1,7	90	PC080+NMRV075	80A6	7380
7,5	283	1,3	120	PC080+NMRV075	80A6	7380
6,0	324	1,0	150	PC080+NMRV075	80A6	7380
4,7	412	0,9	300	NMRV040/075	71B4	7380
3,5	506	0,7	400	NMRV040/075	71B4	7380
11,3	188	1,7	80	NMRV090	80A6	7859
9,0	216	1,3	100	NMRV090	80A6	8180
7,8	268	1,5	180	PC071+NMRV090	71B4	8180
5,8	321	1,1	240	PC071+NMRV090	71B4	8180
4,7	371	0,9	300	PC071+NMRV090	71B4	8180
6,0	347	1,6	150	PC080+NMRV090	80A6	8180
5,0	389	1,3	180	PC080+NMRV090	80A6	8180
3,8	471	1,0	240	PC080+NMRV090	80A6	8180
4,7	408	1,5	300	NMRV040/090	71B4	8180
3,5	532	1,1	400	NMRV040/090	71B4	8180
2,8	622	0,9	500	NMRV040/090	71B4	8180
2,3	779	0,8	600	NMRV040/090	71B4	8180
3,8	509	1,5	240	PC080+NMRV105	80A6	10320
3,0	577	1,2	300	PC080+NMRV105	80A6	10320
1,9	977	1,1	750	NMRV050/105	71B4	10320
1,6	1111	1,0	900	NMRV050/105	71B4	10320
1,2	1437	0,7	1200	NMRV050/105	71B4	10320
3,8	509	1,6	240	PC080+NMRV110	80A6	10320
3,0	577	1,3	300	PC080+NMRV110	80A6	10320
1,9	977	1,3	750	NMRV050/110	71B4	10320
1,6	1111	1,1	900	NMRV050/110	71B4	10320
1,2	1437	0,8	1200	NMRV050/110	71B4	10320
0,93	1699	1,0	1500	NMRV063/130	71B4	13500
0,78	1918	0,9	1800	NMRV063/130	71B4	13500
0,8	2089	1,0	1800	NMRV063/150	71B4	18000
0,6	2519	1,1	2400	NMRV063/150	71B4	18000
0,5	2958	0,8	3000	NMRV063/150	71B4	18000



## 0,55 kW

n2 [1/min]	M2 [Nm]	f.s.	i			Fr [N]
560,0	8	2,8	5	NMRV040	71B2	912
373,3	13	2,2	7,5	NMRV040	71B2	1044
280,0	17	1,8	10	NMRV040	71B2	1149
186,7	24	1,3	15	NMRV040	71B2	1315
140,0	31	0,9	20	NMRV040	71B2	1447
112,0	38	0,7	25	NMRV040	71B2	1559
280,0	17	2,2	5	NMRV040	71C4	1149
186,7	24	1,7	7,5	NMRV040	71C4	1315
140,0	32	1,4	10	NMRV040	71C4	1447
93,3	47	0,9	15	NMRV040	71C4	1657



## 0,55 kW

n2 [1/min]	M2 [Nm]	f.s.	i			Fr [N]
140,0	31	1,7	20	NMRV050	71B2	1987
112,0	38	1,3	25	NMRV050	71B2	2140
93,3	43	1,5	30	NMRV050	71B2	2274
70,0	56	1,1	40	NMRV050	71B2	2503
56,0	66	0,8	50	NMRV050	71B2	2696
46,7	75	0,7	60	NMRV050	71B2	2865
280,0	17	4,1	5	NMRV050	80A4	1577
186,7	25	3,1	7,5	NMRV050	80A4	1805
140,0	33	2,4	10	NMRV050	80A4	1987
93,3	47	1,7	15	NMRV050	80A4	2274
70,0	60	1,3	20	NMRV050	80A4	2503
56,0	72	1,0	25	NMRV050	80A4	2696
46,7	82	1,1	30	NMRV050	80A4	2865
120,0	38	2,4	7,5	NMRV050	80B6	2091
90,0	50	1,9	10	NMRV050	80B6	2302
60,0	70	1,3	15	NMRV050	80B6	2635
45,0	90	0,9	20	NMRV050	80B6	2900
70,0	57	1,9	40	NMRV063	71B2	3272
56,0	68	1,5	50	NMRV063	71B2	3524
46,7	78	1,2	60	NMRV063	71B2	3745
35,0	96	0,9	80	NMRV063	71B2	4122
28,0	111	0,7	100	NMRV063	71B2	4440
70,0	62	2,2	20	NMRV063	80A4	3272
56,0	74	1,8	25	NMRV063	80A4	3524
46,7	84	1,9	30	NMRV063	80A4	3745
35,0	107	1,4	40	NMRV063	80A4	4122
28,0	126	1,1	50	NMRV063	80A4	4440
23,3	142	0,9	60	NMRV063	80A4	4719
60,0	72	2,2	15	NMRV063	80B6	3444
45,0	91	1,6	20	NMRV063	80B6	3791
36,0	111	1,3	25	NMRV063	80B6	4084
30,0	124	1,4	30	NMRV063	80B6	4339
22,5	154	1,0	40	NMRV063	80B6	4776
18,7	200	0,8	75	PC071+NMRV063	71C4	5083
15,6	219	0,9	90	PC071+NMRV063	71C4	5401
35,0	101	1,3	80	NMRV075	71B2	4865
28,0	116	1,0	100	NMRV075	71B2	5241
35,0	110	2,0	40	NMRV075	80A4	4865
28,0	131	1,6	50	NMRV075	80A4	5241
23,3	149	1,3	60	NMRV075	80A4	5569
17,5	183	1,0	80	NMRV075	80A4	6130
14,0	210	0,9	100	NMRV075	80A4	6603
30,0	130	2,0	30	NMRV075	80B6	5122
22,5	161	1,5	40	NMRV075	80B6	5637
18,0	190	1,2	50	NMRV075	80B6	6073
15,0	217	1,0	60	NMRV075	80B6	6453
18,7	205	1,2	75	PC071+NMRV075	71C4	6000
15,6	230	1,3	90	PC071+NMRV075	71C4	6375
11,7	284	1,0	120	PC071+NMRV075	71C4	7017
18,7	205	1,2	75	PC080+NMRV075	80A4	6000
15,6	230	1,3	90	PC080+NMRV075	80A4	6375
11,7	284	1,0	120	PC080+NMRV075	80A4	7017
9,3	332	0,8	150	PC080+NMRV075	80A4	7380
12,0	306	1,1	75	PC080+NMRV075	80B6	6952
10,0	341	1,1	90	PC080+NMRV075	80B6	7380
17,5	192	1,5	80	NMRV090	80A4	6783
14,0	225	1,2	100	NMRV090	80A4	7306
18,0	201	2,1	50	NMRV090	80B6	6719



## 0,55 kW

n2 [1/min]	M2 [Nm]	f.s.	i			Fr [N]
15,0	228	1,7	60	NMRV090	80B6	7140
11,3	280	1,1	80	NMRV090	80B6	7859
9,0	321	0,9	100	NMRV090	80B6	8180
15,6	240	2,3	90	PC080+NMRV090	80A4	7054
11,7	297	1,6	120	PC080+NMRV090	80A4	7764
9,3	355	1,3	150	PC080+NMRV090	80A4	8180
7,8	398	1,0	180	PC080+NMRV090	80A4	8180
10,0	357	2,0	90	PC080+NMRV090	80B6	8174
7,5	441	1,4	120	PC080+NMRV090	80B6	8180
6,0	516	1,1	150	PC080+NMRV090	80B6	8180
5,0	578	0,9	180	PC080+NMRV090	80B6	8180
9,3	306	2,0	300	NMRV040/090	71B2	8180
7,0	403	1,5	400	NMRV040/090	71B2	8180
5,6	470	1,2	500	NMRV040/090	71B2	8180
17,5	204	2,4	80	NMRV105	80A4	8571
14,0	240	1,9	100	NMRV105	80A4	9232
11,3	299	1,8	80	NMRV105	80B6	9931
9,0	344	1,4	100	NMRV105	80B6	10320
7,8	425	1,7	180	PC080+NMRV105	80A4	10320
5,8	513	1,2	240	PC080+NMRV105	80A4	10320
4,7	597	1,0	300	PC080+NMRV105	80A4	10320
7,5	462	2,2	120	PC080+NMRV105	80B6	10320
6,0	552	1,8	150	PC080+NMRV105	80B6	10320
5,0	620	1,5	180	PC080+NMRV105	80B6	10320
3,8	756	1,0	240	PC080+NMRV105	80B6	10320
4,7	656	1,7	300	NMRV050/105	80A4	10320
3,5	849	1,2	400	NMRV050/105	80A4	10320
2,8	1012	1,0	500	NMRV050/105	80A4	10320
2,3	1214	0,8	600	NMRV050/105	80A4	10320
1,9	1452	0,8	750	NMRV050/105	80A4	10320
17,5	204	2,5	80	NMRV110	80A4	8571
14,0	240	2,0	100	NMRV110	80A4	9232
11,3	299	1,9	80	NMRV110	80B6	9931
9,0	344	1,5	100	NMRV110	80B6	10320
7,8	425	1,8	180	PC080+NMRV110	80A4	10320
5,8	513	1,3	240	PC080+NMRV110	80A4	10320
4,7	597	1,0	300	PC080+NMRV110	80A4	10320
7,5	462	2,6	120	PC080+NMRV110	80B6	10320
6,0	552	2,0	150	PC080+NMRV110	80B6	10320
5,0	620	1,6	180	PC080+NMRV110	80B6	10320
3,8	756	1,1	240	PC080+NMRV110	80B6	10320
4,7	656	1,9	300	NMRV050/110	80A4	10320
3,5	849	1,4	400	NMRV050/110	80A4	10320
2,8	1012	1,1	500	NMRV050/110	80A4	10320
2,3	1214	1,0	600	NMRV050/110	80A4	10320
1,9	1452	0,9	750	NMRV050/110	80A4	10320
3,8	756	1,6	240	PC080+NMRV130	80B6	13500
3,0	858	1,3	300	PC080+NMRV130	80B6	13500
2,8	1012	1,5	500	NMRV063/130	80A4	13500
1,9	1489	1,2	750	NMRV063/130	80A4	13500
1,2	2195	0,8	1200	NMRV063/130	80A4	13500
0,8	3106	0,7	1800	NMRV063/150	80A4	18000
0,6	3744	0,7	2400	NMRV063/150	80A4	18000

## 0,75 kW



n2 [1/min]	M2 [Nm]	f.s.	i			Fr [N]
560,0	12	2,1	5	NMRV040	71C2	912
373,3	17	1,6	7,5	NMRV040	71C2	1044
280,0	23	1,3	10	NMRV040	71C2	1149
186,7	33	1,0	15	NMRV040	71C2	1315
560,0	12	3,9	5	NMRV050	80A2	1251
373,3	17	3,0	7,5	NMRV050	80A2	1433
280,0	23	2,4	10	NMRV050	80A2	1577
186,7	33	1,7	15	NMRV050	80A2	1805
140,0	42	1,2	20	NMRV050	80A2	1987
112,0	52	1,0	25	NMRV050	80A2	2140
93,3	59	1,1	30	NMRV050	80A2	2274
280,0	23	3,0	5	NMRV050	80B4	1577
186,7	34	2,3	7,5	NMRV050	80B4	1805
140,0	45	1,8	10	NMRV050	80B4	1987
93,3	64	1,3	15	NMRV050	80B4	2274
70,0	82	1,0	20	NMRV050	80B4	2503
140,0	43	2,3	20	NMRV063	80A2	2597
112,0	53	1,7	25	NMRV063	80A2	2797
93,3	61	2,0	30	NMRV063	80A2	2973
70,0	78	1,4	40	NMRV063	80A2	3272
56,0	92	1,1	50	NMRV063	80A2	3524
46,7	106	0,9	60	NMRV063	80A2	3745
93,3	64	2,2	15	NMRV063	80B4	2973
70,0	84	1,6	20	NMRV063	80B4	3272
56,0	101	1,3	25	NMRV063	80B4	3524
46,7	115	1,4	30	NMRV063	80B4	3745
35,0	145	1,0	40	NMRV063	80B4	4122
120,0	53	2,9	7,5	NMRV063	90S6	2734
90,0	68	2,3	10	NMRV063	90S6	3009
60,0	98	1,6	15	NMRV063	90S6	3444
45,0	124	1,2	20	NMRV063	90S6	3791
36,0	151	0,9	25	NMRV063	90S6	4084
30,0	170	1,0	30	NMRV063	90S6	4339
46,7	111	1,3	60	NMRV075	80A2	4421
28,0	159	0,8	100	NMRV075	80A2	5241
56,0	104	1,9	25	NMRV075	80B4	4160
46,7	118	1,9	30	NMRV075	80B4	4421
35,0	149	1,5	40	NMRV075	80B4	4865
28,0	179	1,2	50	NMRV075	80B4	5241
23,3	203	1,0	60	NMRV075	80B4	5569
60,0	99	2,4	15	NMRV075	90S6	4065
45,0	127	1,8	20	NMRV075	90S6	4474
36,0	155	1,4	25	NMRV075	90S6	4820
30,0	177	1,5	30	NMRV075	90S6	5122
22,5	220	1,1	40	NMRV075	90S6	5637
18,7	280	0,9	75	PC080+NMRV075	80B4	6000
15,6	313	1,0	90	PC080+NMRV075	80B4	6375
35,0	143	1,6	80	NMRV090	80A2	5383
28,0	169	1,2	100	NMRV090	80A2	5799
28,0	187	2,0	50	NMRV090	80B4	5799
23,3	215	1,6	60	NMRV090	80B4	6163
17,5	262	1,1	80	NMRV090	80B4	6783
14,0	307	0,9	100	NMRV090	80B4	7306
30,0	181	2,7	30	NMRV090	90S6	5667
22,5	229	2,0	40	NMRV090	90S6	6238
18,0	275	1,6	50	NMRV090	90S6	6719
15,0	310	1,2	60	NMRV090	90S6	7140
15,6	327	1,7	90	PC080+NMRV090	80B4	7054

## 0,75 kW



n2 [1/min]	M2 [Nm]	f.s.	i			Fr [N]
11,7	405	1,2	120	PC080+NMRV090	80B4	7764
9,3	483	0,9	150	PC080+NMRV090	80B4	8180
7,8	543	0,7	180	PC080+NMRV090	80B4	8180
7,0	549	1,1	400	NMRV040/090	71C2	8180
5,6	642	0,9	500	NMRV040/090	71C2	8180
17,5	278	1,8	80	NMRV105	80B4	8571
14,0	327	1,4	100	NMRV105	80B4	9232
15,0	329	1,9	60	NMRV105	90S6	9023
11,3	407	1,3	80	NMRV105	90S6	9931
9,0	470	1,0	100	NMRV105	90S6	10320
11,7	430	1,9	120	PC080+NMRV105	80B4	9811
9,3	506	1,6	150	PC080+NMRV105	80B4	10320
7,8	580	1,2	180	PC080+NMRV105	80B4	10320
5,8	700	0,9	240	PC080+NMRV105	80B4	10320
12,4	393	2,8	72,6	PC090+NMRV105	90S6	9614
9,3	508	2,0	96,8	PC090+NMRV105	90S6	10320
7,4	607	1,6	121	PC090+NMRV105	90S6	10320
6,2	682	1,3	145,2	PC090+NMRV105	90S6	10320
4,6	832	0,9	193,6	PC090+NMRV105	90S6	10320
9,3	446	2,5	300	NMRV050/105	80A2	10320
7,0	563	1,8	400	NMRV050/105	80A2	10320
5,6	687	1,5	500	NMRV050/105	80A2	10320
4,7	895	1,2	300	NMRV050/105	80B4	10320
3,5	1157	0,9	400	NMRV050/105	80B4	10320
17,5	278	1,9	80	NMRV110	80B4	8571
14,0	327	1,5	100	NMRV110	80B4	9232
15,0	329	2,1	60	NMRV110	90S6	9023
11,3	407	1,4	80	NMRV110	90S6	9931
9,0	470	1,1	100	NMRV110	90S6	10320
11,7	430	2,2	120	PC080+NMRV110	80B4	9811
9,3	506	1,7	150	PC080+NMRV110	80B4	10320
7,8	580	1,3	180	PC080+NMRV110	80B4	10320
5,8	700	0,9	240	PC080+NMRV110	80B4	10320
12,4	393	3,2	72,6	PC090+NMRV110	90S6	9614
9,3	508	2,3	96,8	PC090+NMRV110	90S6	10320
7,4	607	1,8	121	PC090+NMRV110	90S6	10320
6,2	682	1,5	145,2	PC090+NMRV110	90S6	10320
4,6	832	1,0	193,6	PC090+NMRV110	90S6	10320
9,3	446	2,8	300	NMRV050/110	80A2	10320
7,0	563	2,1	400	NMRV050/110	80A2	10320
5,6	687	1,6	500	NMRV050/110	80A2	10320
4,7	895	1,4	300	NMRV050/110	80B4	10320
3,5	1157	1,0	400	NMRV050/110	80B4	10320
11,3	414	2,1	80	NMRV130	90S6	12989
9,0	478	1,6	100	NMRV130	90S6	13500
5,8	712	1,4	240	PC080+NMRV130	80B4	13500
4,7	813	1,1	300	PC080+NMRV130	80B4	13500
12,4	399	4,4	72,6	PC090+NMRV130	90S6	12575
9,3	508	3,2	96,8	PC090+NMRV130	90S6	13500
7,4	607	2,6	121	PC090+NMRV130	90S6	13500
6,2	682	2,1	145,2	PC090+NMRV130	90S6	13500
4,6	832	1,5	193,6	PC090+NMRV130	90S6	13500
3,7	944	1,2	242	PC090+NMRV130	90S6	13500
2,8	1380	1,1	500	NMRV063/130	80B4	13500
2,3	1676	1,0	600	NMRV063/130	80B4	13500
1,9	2031	0,9	750	NMRV063/130	80B4	13500
1,6	2314	0,8	900	NMRV063/130	80B4	13500
2,8	1380	1,7	500	NMRV063/150	80B4	18000





## 0,75 kW

n2 [1/min]	M2 [Nm]	f.s.	i			Fr [N]
2,3	1702	1,6	600	NMRV063/150	80B4	18000
1,9	1998	1,2	750	NMRV063/150	80B4	18000
1,6	2521	0,8	900	NMRV063/150	80B4	18000
1,2	3039	0,9	1200	NMRV063/150	80B4	18000



## 0,92 kW

n2 [1/min]	M2 [Nm]	f.s.	i			Fr [N]
280,0	28	2,4	5	NMRV050	80C4	1577
186,7	41	1,9	7,5	NMRV050	80C4	1805
140,0	55	1,4	10	NMRV050	80C4	1987
93,3	78	1,0	15	NMRV050	80C4	2274
140,0	55	2,4	10	NMRV063	80C4	2597
93,3	79	1,8	15	NMRV063	80C4	2973
70,0	103	1,3	20	NMRV063	80C4	3272
56,0	124	1,0	25	NMRV063	80C4	3524
46,7	141	1,1	30	NMRV063	80C4	3745
35,0	178	0,8	40	NMRV063	80C4	4122
70,0	104	2,0	20	NMRV075	80C4	3862
56,0	127	1,6	25	NMRV075	80C4	4160
46,7	145	1,6	30	NMRV075	80C4	4421
35,0	183	1,2	40	NMRV075	80C4	4865
28,0	220	1,0	50	NMRV075	80C4	5241
23,3	249	0,8	60	NMRV075	80C4	5569
18,7	344	0,7	75	PC080+NMRV075	80C4	6000
15,6	384	0,8	90	PC080+NMRV075	80C4	6375
28,0	229	1,6	50	NMRV090	80C4	5799
23,3	264	1,3	60	NMRV090	80C4	6163
17,5	321	0,9	80	NMRV090	80C4	6783
23,3	294	1,6	60	PC080+NMRV090	80C4	6163
15,6	401	1,4	90	PC080+NMRV090	80C4	7054
11,7	497	1,0	120	PC080+NMRV090	80C4	7764
9,3	593	0,8	150	PC080+NMRV090	80C4	8180
17,5	341	1,4	80	NMRV105	80C4	8571
14,0	402	1,1	100	NMRV105	80C4	9232
18,7	367	2,2	75	PC080+NMRV105	80C4	8388
11,7	527	1,5	120	PC080+NMRV105	80C4	9811
9,3	621	1,3	150	PC080+NMRV105	80C4	10320
7,8	712	1,0	180	PC080+NMRV105	80C4	10320
4,7	1097	1,0	300	NMRV050/105	80C4	10320
3,5	1420	0,7	400	NMRV050/105	80C4	10320
17,5	341	1,5	80	NMRV110	80C4	8571
14,0	402	1,2	100	NMRV110	80C4	9232
18,7	367	2,5	75	PC080+NMRV110	80C4	8388
11,7	527	1,8	120	PC080+NMRV110	80C4	9811
9,3	621	1,4	150	PC080+NMRV110	80C4	10320
7,8	712	1,1	180	PC080+NMRV110	80C4	10320
4,7	1097	1,2	300	NMRV050/110	80C4	10320
3,5	1420	0,8	400	NMRV050/110	80C4	10320
3,5	1420	1,2	400	NMRV063/130	80C4	13500
2,8	1693	0,9	500	NMRV063/130	80C4	13500
7,8	712	1,5	180	PC080+NMRV130	80C4	13500
5,8	874	1,1	240	PC080+NMRV130	80C4	13500
4,7	998	0,9	300	PC080+NMRV130	80C4	13500
2,8	1693	1,4	500	NMRV063/150	80C4	18000
2,3	2088	1,3	600	NMRV063/150	80C4	18000



## 0,92 kW

n2 [1/min]	M2 [Nm]	f.s.	i			Fr [N]
1,9	2451	1,0	750	NMRV063/150	80C4	18000
1,6	3092	0,7	900	NMRV063/150	80C4	18000
1,2	3728	0,7	1200	NMRV063/150	80C4	18000



## 1,10 kW

n2 [1/min]	M2 [Nm]	f.s.	i			Fr [N]
560,0	17	2,6	5	NMRV050	80B2	1251
373,3	25	2,1	7,5	NMRV050	80B2	1433
280,0	33	1,6	10	NMRV050	80B2	1577
186,7	48	1,2	15	NMRV050	80B2	1805
140,0	62	0,9	20	NMRV050	80B2	1987
186,7	49	2,1	15	NMRV063	80B2	2359
140,0	64	1,6	20	NMRV063	80B2	2597
112,0	78	1,2	25	NMRV063	80B2	2797
93,3	89	1,3	30	NMRV063	80B2	2973
70,0	114	0,9	40	NMRV063	80B2	3272
120,0	77	2,0	7,5	NMRV063	90L6	2734
90,0	99	1,5	10	NMRV063	90L6	3009
60,0	144	1,1	15	NMRV063	90L6	3444
45,0	182	0,8	20	NMRV063	90L6	3791
186,7	50	2,6	7,5	NMRV063	90S4	2359
140,0	65	2,0	10	NMRV063	90S4	2597
93,3	95	1,5	15	NMRV063	90S4	2973
70,0	123	1,1	20	NMRV063	90S4	3272
56,0	148	0,9	25	NMRV063	90S4	3524
46,7	169	0,9	30	NMRV063	90S4	3745
112,0	79	1,9	25	NMRV075	80B2	3302
93,3	91	1,9	30	NMRV075	80B2	3509
70,0	117	1,4	40	NMRV075	80B2	3862
56,0	141	1,1	50	NMRV075	80B2	4160
46,7	162	0,9	60	NMRV075	80B2	4421
90,0	100	2,3	10	NMRV075	90L6	3551
60,0	145	1,6	15	NMRV075	90L6	4065
45,0	187	1,3	20	NMRV075	90L6	4474
36,0	228	1,0	25	NMRV075	90L6	4820
30,0	259	1,0	30	NMRV075	90L6	5122
93,3	97	2,1	15	NMRV075	90S4	3509
70,0	125	1,7	20	NMRV075	90S4	3862
56,0	152	1,3	25	NMRV075	90S4	4160
46,7	173	1,3	30	NMRV075	90S4	4421
35,0	219	1,0	40	NMRV075	90S4	4865
35,0	210	1,1	80	NMRV090	80B2	5383
28,0	248	0,8	100	NMRV090	80B2	5799
36,0	233	1,7	25	NMRV090	90L6	5333
30,0	266	1,8	30	NMRV090	90L6	5667
22,5	336	1,3	40	NMRV090	90L6	6238
18,0	403	1,1	50	NMRV090	90L6	6719
15,0	455	0,8	60	NMRV090	90L6	7140
35,0	228	1,7	40	NMRV090	90S4	5383
28,0	274	1,4	50	NMRV090	90S4	5799
23,3	315	1,1	60	NMRV090	90S4	6163
22,5	350	2,2	40	NMRV105	90L6	7882
18,0	420	1,7	50	NMRV105	90L6	8491
15,0	483	1,3	60	NMRV105	90L6	9023
11,3	598	0,9	80	NMRV105	90L6	9931



## 1,10 kW

n2 [1/min]	M2 [Nm]	f.s.	i			Fr [N]
28,0	285	2,3	50	NMRV105	90S4	7328
23,3	329	1,7	60	NMRV105	90S4	7787
17,5	408	1,2	80	NMRV105	90S4	8571
14,0	480	1,0	100	NMRV105	90S4	9232
12,4	576	1,9	72,6	PC090+NMRV105	90L6	9614
9,3	746	1,4	96,8	PC090+NMRV105	90L6	10320
7,4	890	1,1	121	PC090+NMRV105	90L6	10320
6,2	1000	0,9	145,2	PC090+NMRV105	90L6	10320
19,3	392	2,2	72,6	PC090+NMRV105	90S4	8298
14,5	508	1,6	96,8	PC090+NMRV105	90S4	9133
11,6	599	1,3	121	PC090+NMRV105	90S4	9838
9,6	686	1,0	145,2	PC090+NMRV105	90S4	10320
7,2	828	0,8	193,6	PC090+NMRV105	90S4	10320
9,3	654	1,7	300	NMRV050/105	80B2	10320
7,0	845	1,2	400	NMRV050/105	80B2	10320
5,6	1007	1,0	500	NMRV050/105	80B2	10320
22,5	350	2,3	40	NMRV110	90L6	7882
18,0	420	1,8	50	NMRV110	90L6	8491
15,0	483	1,4	60	NMRV110	90L6	9023
11,3	598	0,9	80	NMRV110	90L6	9931
28,0	285	2,3	50	NMRV110	90S4	7328
23,3	331	1,9	60	NMRV110	90S4	7787
17,5	408	1,3	80	NMRV110	90S4	8571
14,0	480	1,0	100	NMRV110	90S4	9232
12,4	576	2,2	72,6	PC090+NMRV110	90L6	9614
9,3	746	1,6	96,8	PC090+NMRV110	90L6	10320
7,4	890	1,2	121	PC090+NMRV110	90L6	10320
6,2	1000	1,0	145,2	PC090+NMRV110	90L6	10320
19,3	392	2,5	72,6	PC090+NMRV110	90S4	8298
14,5	508	1,8	96,8	PC090+NMRV110	90S4	9133
11,6	599	1,5	121	PC090+NMRV110	90S4	9838
9,6	686	1,1	145,2	PC090+NMRV110	90S4	10320
7,2	828	0,8	193,6	PC090+NMRV110	90S4	10320
9,3	654	1,9	300	NMRV050/110	80B2	10320
7,0	845	1,4	400	NMRV050/110	80B2	10320
5,6	1007	1,1	500	NMRV050/110	80B2	10320
11,3	607	1,4	80	NMRV130	90L6	12989
9,0	700	1,1	100	NMRV130	90L6	13500
17,5	414	2,0	80	NMRV130	90S4	11210
14,0	488	1,5	100	NMRV130	90S4	12076
12,4	585	3,0	72,6	PC090+NMRV130	90L6	12575
9,3	746	2,2	96,8	PC090+NMRV130	90L6	13500
7,4	890	1,7	121	PC090+NMRV130	90L6	13500
6,2	1000	1,4	145,2	PC090+NMRV130	90L6	13500
4,6	1220	1,0	193,6	PC090+NMRV130	90L6	13500
19,3	398	3,5	72,6	PC090+NMRV130	90S4	10853
14,5	508	2,6	96,8	PC090+NMRV130	90S4	11945
11,6	608	2,0	121	PC090+NMRV130	90S4	12868
9,6	686	1,6	145,2	PC090+NMRV130	90S4	13500
7,2	843	1,2	193,6	PC090+NMRV130	90S4	13500
5,8	962	0,9	242	PC090+NMRV130	90S4	13500
4,7	1332	1,3	300	NMRV063/130	90S4	13500
3,5	1697	1,0	400	NMRV063/130	90S4	13500
2,8	2024	0,8	500	NMRV063/130	90S4	13500
9,3	771	3,0	150	NMRV063/150	90S4	18000
7,0	1005	2,3	200	NMRV063/150	90S4	18000
5,6	1224	1,7	250	NMRV063/150	90S4	18000
4,7	1456	1,6	300	NMRV063/150	90S4	18000



## 1,10 kW

n2 [1/min]	M2 [Nm]	f.s.	i			Fr [N]
3,5	1723	1,5	400	NMRV063/150	90S4	18000
2,8	2024	1,2	500	NMRV063/150	90S4	18000
2,3	2496	1,1	600	NMRV063/150	90S4	18000
1,9	2931	0,8	750	NMRV063/150	90S4	18000



## 1,50 kW

n2 [1/min]	M2 [Nm]	f.s.	i			Fr [N]
560,0	23	1,9	5	NMRV050	80C2	1251
373,3	35	1,5	7,5	NMRV050	80C2	1433
280,0	46	1,2	10	NMRV050	80C2	1577
186,7	66	0,9	15	NMRV050	80C2	1805
186,7	68	1,9	7,5	NMRV063	90L4	2359
140,0	89	1,5	10	NMRV063	90L4	2597
93,3	129	1,1	15	NMRV063	90L4	2973
70,0	168	0,8	20	NMRV063	90L4	3272
373,3	35	2,7	7,5	NMRV063	90S2	1873
280,0	46	2,1	10	NMRV063	90S2	2061
186,7	67	1,5	15	NMRV063	90S2	2359
140,0	87	1,1	20	NMRV063	90S2	2597
112,0	106	0,9	25	NMRV063	90S2	2797
93,3	121	1,0	30	NMRV063	90S2	2973
120,0	105	2,0	7,5	NMRV075	100LA6	3227
90,0	137	1,7	10	NMRV075	100LA6	3551
60,0	198	1,2	15	NMRV075	100LA6	4065
56,0	192	0,8	50	NMRV075	90S2	4160
46,7	221	0,7	60	NMRV075	90S2	4421
140,0	90	2,2	10	NMRV075	90L4	3065
93,3	132	1,5	15	NMRV075	90L4	3509
70,0	170	1,2	20	NMRV075	90L4	3862
56,0	207	1,0	25	NMRV075	90L4	4160
46,7	236	1,0	30	NMRV075	90L4	4421
280,0	46	3,1	10	NMRV075	90S2	2433
186,7	68	2,2	15	NMRV075	90S2	2785
140,0	88	1,8	20	NMRV075	90S2	3065
112,0	107	1,4	25	NMRV075	90S2	3302
93,3	124	1,4	30	NMRV075	90S2	3509
70,0	160	1,0	40	NMRV075	90S2	3862
90,0	138	2,9	10	NMRV090	100LA6	3929
60,0	203	2,3	15	NMRV090	100LA6	4498
45,0	261	1,6	20	NMRV090	100LA6	4951
36,0	318	1,3	25	NMRV090	100LA6	5333
30,0	363	1,3	30	NMRV090	100LA6	5667
70,0	174	2,2	20	NMRV090	90L4	4273
56,0	212	1,8	25	NMRV090	90L4	4603
46,7	243	1,8	30	NMRV090	90L4	4891
35,0	311	1,3	40	NMRV090	90L4	5383
28,0	373	1,0	50	NMRV090	90L4	5799
23,3	430	0,8	60	NMRV090	90L4	6163
56,0	197	1,3	50	NMRV090	90S2	4603
46,7	230	1,1	60	NMRV090	90S2	4891
45,0	267	2,6	20	NMRV105	100LA6	6256
36,0	326	2,0	25	NMRV105	100LA6	6739
30,0	368	2,1	30	NMRV105	100LA6	7161
22,5	478	1,6	40	NMRV105	100LA6	7882
18,0	573	1,3	50	NMRV105	100LA6	8491



## 1,50 kW

n2 [1/min]	M2 [Nm]	f.s.	i			Fr [N]
15,0	659	1,0	60	NMRV105	100LA6	9023
35,0	323	2,1	40	NMRV105	90L4	6803
28,0	389	1,7	50	NMRV105	90L4	7328
23,3	448	1,3	60	NMRV105	90L4	7787
17,5	557	0,9	80	NMRV105	90L4	8571
46,7	239	1,8	60	NMRV105	90S2	6181
35,0	303	1,3	80	NMRV105	90S2	6803
28,0	358	1,0	100	NMRV105	90S2	7328
19,3	535	1,6	72,6	PC090+NMRV105	90L4	8298
14,5	693	1,2	96,8	PC090+NMRV105	90L4	9133
11,6	817	1,0	121	PC090+NMRV105	90L4	9838
9,6	936	0,8	145,2	PC090+NMRV105	90L4	10320
9,3	891	1,2	300	NMRV050/105	80C2	10320
7,0	1153	0,9	400	NMRV050/105	80C2	10320
5,6	1373	0,7	500	NMRV050/105	80C2	10320
45,0	267	2,7	20	NMRV110	100LA6	6256
36,0	326	2,3	25	NMRV110	100LA6	6739
30,0	368	2,3	30	NMRV110	100LA6	7161
22,5	478	1,7	40	NMRV110	100LA6	7882
18,0	573	1,3	50	NMRV110	100LA6	8491
15,0	659	1,0	60	NMRV110	100LA6	9023
35,0	323	2,2	40	NMRV110	90L4	6803
28,0	389	1,7	50	NMRV110	90L4	7328
23,3	452	1,4	60	NMRV110	90L4	7787
17,5	557	0,9	80	NMRV110	90L4	8571
46,7	239	2,0	60	NMRV110	90S2	6181
35,0	303	1,3	80	NMRV110	90S2	6803
28,0	358	1,0	100	NMRV110	90S2	7328
19,3	535	1,9	72,6	PC090+NMRV110	90L4	8298
14,5	693	1,3	96,8	PC090+NMRV110	90L4	9133
11,6	817	1,1	121	PC090+NMRV110	90L4	9838
9,6	936	0,8	145,2	PC090+NMRV110	90L4	10320
9,3	891	1,4	300	NMRV050/110	80C2	10320
7,0	1153	1,0	400	NMRV050/110	80C2	10320
5,6	1373	0,8	500	NMRV050/110	80C2	10320
22,5	484	2,3	40	NMRV130	100LA6	10309
18,0	581	1,8	50	NMRV130	100LA6	11105
15,0	669	1,4	60	NMRV130	100LA6	11801
11,3	828	1,0	80	NMRV130	100LA6	12989
17,5	565	1,5	80	NMRV130	90L4	11210
14,0	665	1,1	100	NMRV130	90L4	12076
19,3	542	2,6	72,6	PC090+NMRV130	90L4	10853
14,5	693	1,9	96,8	PC090+NMRV130	90L4	11945
11,6	830	1,5	121	PC090+NMRV130	90L4	12868
9,6	936	1,1	145,2	PC090+NMRV130	90L4	13500
7,2	1149	0,8	193,6	PC090+NMRV130	90L4	13500
9,3	915	1,9	300	NMRV063/130	90S2	13500
7,0	1166	1,4	400	NMRV063/130	90S2	13500
5,6	1389	1,1	500	NMRV063/130	90S2	13500
4,7	1816	1,0	300	NMRV063/130	90L4	13500
3,5	2315	0,7	400	NMRV063/130	90L4	13500
9,3	1052	2,2	150	NMRV063/150	90L4	18000
7,0	1371	1,7	200	NMRV063/150	90L4	18000
5,6	1669	1,2	250	NMRV063/150	90L4	18000
4,7	1985	1,2	300	NMRV063/150	90L4	18000
3,5	2350	1,1	400	NMRV063/150	90L4	18000
2,8	2760	0,8	500	NMRV063/150	90L4	18000
2,3	3404	0,8	600	NMRV063/150	90L4	18000



## 1,84 kW

n2 [1/min]	M2 [Nm]	f.s.	i			Fr [N]
186,7	84	1,5	7,5	NMRV063	90LL4	2359
140,0	109	1,2	10	NMRV063	90LL4	2597
93,3	158	0,9	15	NMRV063	90LL4	2973
186,7	84	2,2	7,5	NMRV075	90LL4	2785
140,0	110	1,8	10	NMRV075	90LL4	3065
93,3	162	1,2	15	NMRV075	90LL4	3509
70,0	208	1,0	20	NMRV075	90LL4	3862
56,0	254	0,8	25	NMRV075	90LL4	4160
46,7	290	0,8	30	NMRV075	90LL4	4421
70,0	213	1,8	20	NMRV090	90LL4	4273
56,0	260	1,4	25	NMRV090	90LL4	4603
46,7	297	1,5	30	NMRV090	90LL4	4891
35,0	382	1,0	40	NMRV090	90LL4	5383
28,0	458	0,8	50	NMRV090	90LL4	5799
56,0	267	2,2	25	NMRV105	90LL4	5816
35,0	397	1,7	40	NMRV105	90LL4	6803
28,0	477	1,4	50	NMRV105	90LL4	7328
23,3	550	1,0	60	NMRV105	90LL4	7787
19,3	656	1,3	72,6	PC090+NMRV105	90LL4	8298
14,5	850	1,0	96,8	PC090+NMRV105	90LL4	9133
11,6	1002	0,8	121	PC090+NMRV105	90LL4	9838
56,0	267	2,5	25	NMRV110	90LL4	5816
35,0	397	1,8	40	NMRV110	90LL4	6803
28,0	477	1,4	50	NMRV110	90LL4	7328
23,3	554	1,1	60	NMRV110	90LL4	7787
19,3	656	1,5	72,6	PC090+NMRV110	90LL4	8298
14,5	850	1,1	96,8	PC090+NMRV110	90LL4	9133
11,6	1002	0,9	121	PC090+NMRV110	90LL4	9838
17,5	693	1,2	80	NMRV130	90LL4	11210
14,0	816	0,9	100	NMRV130	90LL4	12076
19,3	665	2,1	72,6	PC090+NMRV130	90LL4	10853
14,5	850	1,5	96,8	PC090+NMRV130	90LL4	11945
11,6	1018	1,2	121	PC090+NMRV130	90LL4	12868
9,6	1148	0,9	145,2	PC090+NMRV130	90LL4	13500
9,3	1290	1,8	150	NMRV063/150	90LL4	18000
7,0	1682	1,4	200	NMRV063/150	90LL4	18000
5,6	2047	1,0	250	NMRV063/150	90LL4	18000
4,7	2435	1,0	300	NMRV063/150	90LL4	18000
3,5	2883	0,9	400	NMRV063/150	90LL4	18000
2,8	3385	0,7	500	NMRV063/150	90LL4	18000



## 2,20 kW

n2 [1/min]	M2 [Nm]	f.s.	i			Fr [N]
373,3	51	1,8	7,5	NMRV063	90L2	1873
280,0	67	1,5	10	NMRV063	90L2	2061
186,7	98	1,1	15	NMRV063	90L2	2359
186,7	100	1,8	7,5	NMRV075	100LA4	2785
140,0	132	1,5	10	NMRV075	100LA4	3065
93,3	194	1,0	15	NMRV075	100LA4	3509
373,3	51	2,5	7,5	NMRV075	90L2	2210
280,0	68	2,1	10	NMRV075	90L2	2433
186,7	99	1,5	15	NMRV075	90L2	2785
140,0	129	1,2	20	NMRV075	90L2	3065
112,0	158	1,0	25	NMRV075	90L2	3302
93,3	182	0,9	30	NMRV075	90L2	3509



## 2,20 kW

n2 [1/min]	M2 [Nm]	f.s.	i			Fr [N]
186,7	101	3,1	7,5	NMRV090	100LA4	3081
140,0	134	2,6	10	NMRV090	100LA4	3391
93,3	196	2,0	15	NMRV090	100LA4	3882
70,0	255	1,5	20	NMRV090	100LA4	4273
56,0	311	1,2	25	NMRV090	100LA4	4603
46,7	356	1,2	30	NMRV090	100LA4	4891
120,0	156	2,4	7,5	NMRV090	112M6	3570
90,0	203	2,0	10	NMRV090	112M6	3929
60,0	298	1,6	15	NMRV090	112M6	4498
45,0	383	1,1	20	NMRV090	112M6	4951
140,0	132	2,0	20	NMRV090	90L2	3391
112,0	161	1,5	25	NMRV090	90L2	3653
93,3	187	1,7	30	NMRV090	90L2	3882
70,0	240	1,1	40	NMRV090	90L2	4273
56,0	289	0,9	50	NMRV090	90L2	4603
70,0	258	2,4	20	NMRV105	100LA4	5399
56,0	319	1,9	25	NMRV105	100LA4	5816
46,7	360	1,8	30	NMRV105	100LA4	6181
35,0	474	1,4	40	NMRV105	100LA4	6803
28,0	570	1,1	50	NMRV105	100LA4	7328
23,3	657	0,9	60	NMRV105	100LA4	7787
90,0	205	3,3	10	NMRV105	112M6	4965
60,0	301	2,3	15	NMRV105	112M6	5684
45,0	392	1,8	20	NMRV105	112M6	6256
36,0	479	1,4	25	NMRV105	112M6	6739
30,0	539	1,4	30	NMRV105	112M6	7161
112,0	165	2,7	25	NMRV105	90L2	4616
93,3	189	2,5	30	NMRV105	90L2	4905
70,0	249	1,8	40	NMRV105	90L2	5399
56,0	300	1,5	50	NMRV105	90L2	5816
46,7	351	1,2	60	NMRV105	90L2	6181
38,6	398	1,8	72,6	PC090+NMRV105	90L2	6586
28,9	516	1,3	96,8	PC090+NMRV105	90L2	7249
23,1	617	1,1	121	PC090+NMRV105	90L2	7809
70,0	258	2,5	20	NMRV110	100LA4	5399
56,0	319	2,1	25	NMRV110	100LA4	5816
46,7	360	2,0	30	NMRV110	100LA4	6181
35,0	474	1,5	40	NMRV110	100LA4	6803
28,0	570	1,2	50	NMRV110	100LA4	7328
23,3	663	0,9	60	NMRV110	100LA4	7787
90,0	205	3,5	10	NMRV110	112M6	4965
60,0	301	2,5	15	NMRV110	112M6	5684
45,0	392	1,8	20	NMRV110	112M6	6256
36,0	479	1,6	25	NMRV110	112M6	6739
30,0	539	1,6	30	NMRV110	112M6	7161
112,0	165	3,1	25	NMRV110	90L2	4616
93,3	189	2,9	30	NMRV110	90L2	4905
70,0	249	2,1	40	NMRV110	90L2	5399
56,0	300	1,6	50	NMRV110	90L2	5816
46,7	351	1,3	60	NMRV110	90L2	6181
38,6	398	2,1	72,6	PC090+NMRV110	90L2	6586
28,9	516	1,5	96,8	PC090+NMRV110	90L2	7249
23,1	617	1,2	121	PC090+NMRV110	90L2	7809
35,0	474	2,2	40	NMRV130	100LA4	8897
28,0	570	1,7	50	NMRV130	100LA4	9584
23,3	657	1,4	60	NMRV130	100LA4	10185
17,5	828	1,0	80	NMRV130	100LA4	11210
36,0	484	2,2	25	NMRV130	112M6	8814

## 2,20 kW



n2 [1/min]	M2 [Nm]	f.s.	i			Fr [N]
30,0	553	2,1	30	NMRV130	112M6	9366
22,5	710	1,6	40	NMRV130	112M6	10309
18,0	852	1,2	50	NMRV130	112M6	11105
15,0	980	1,0	60	NMRV130	112M6	11801
35,0	444	1,3	80	NMRV130	90L2	8897
28,0	533	1,0	100	NMRV130	90L2	9584
38,6	409	2,9	72,6	PC090+NMRV130	90L2	8614
28,9	545	2,0	96,8	PC090+NMRV130	90L2	9481
23,1	654	1,6	121	PC090+NMRV130	90L2	10213
19,3	752	1,3	145,2	PC090+NMRV130	90L2	10853
28,0	578	2,4	50	NMRV150	100LA4	13103
23,3	666	1,9	60	NMRV150	100LA4	13924
17,5	828	1,4	80	NMRV150	100LA4	15325
14,0	975	1,0	100	NMRV150	100LA4	16508

## 3,00 kW



n2 [1/min]	M2 [Nm]	f.s.	i			Fr [N]
373,3	70	1,9	7,5	NMRV075	100LA2	2210
280,0	92	1,6	10	NMRV075	100LA2	2433
186,7	137	1,4	7,5	NMRV075	100LB4	2785
140,0	180	1,1	10	NMRV075	100LB4	3065
93,3	264	0,8	15	NMRV075	100LB4	3509
373,3	71	3,0	7,5	NMRV090	100LA2	2446
280,0	92	2,6	10	NMRV090	100LA2	2692
186,7	138	2,3	7,5	NMRV090	100LB4	3081
140,0	182	1,9	10	NMRV090	100LB4	3391
93,3	267	1,5	15	NMRV090	100LB4	3882
70,0	348	1,1	20	NMRV090	100LB4	4273
56,0	425	0,9	25	NMRV090	100LB4	4603
46,7	485	0,9	30	NMRV090	100LB4	4891
93,3	267	2,3	15	NMRV105	100LB4	4905
70,0	352	1,8	20	NMRV105	100LB4	5399
56,0	435	1,4	25	NMRV105	100LB4	5816
46,7	491	1,4	30	NMRV105	100LB4	6181
35,0	647	1,1	40	NMRV105	100LB4	6803
28,0	778	0,8	50	NMRV105	100LB4	7328
120,0	212	2,9	7,5	NMRV105	132S6	4511
90,0	280	2,4	10	NMRV105	132S6	4965
60,0	411	1,7	15	NMRV105	132S6	5684
45,0	535	1,3	20	NMRV105	132S6	6256
93,3	267	2,5	15	NMRV110	100LB4	4905
70,0	352	1,8	20	NMRV110	100LB4	5399
56,0	435	1,6	25	NMRV110	100LB4	5816
46,7	491	1,5	30	NMRV110	100LB4	6181
35,0	647	1,1	40	NMRV110	100LB4	6803
28,0	778	0,8	50	NMRV110	100LB4	7328
120,0	212	3,1	7,5	NMRV110	132S6	4511
90,0	280	2,5	10	NMRV110	132S6	4965
60,0	411	1,8	15	NMRV110	132S6	5684
45,0	535	1,4	20	NMRV110	132S6	6256
56,0	435	2,1	25	NMRV130	100LB4	7607
46,7	497	2,1	30	NMRV130	100LB4	8084
35,0	647	1,6	40	NMRV130	100LB4	8897
28,0	778	1,3	50	NMRV130	100LB4	9584
23,3	896	1,0	60	NMRV130	100LB4	10185





### 3,00 kW

n2 [1/min]	M2 [Nm]	f.s.	i			Fr [N]
17,5	1130	0,7	80	NMRV130	100LB4	11210
90,0	280	3,4	10	NMRV130	132S6	6494
60,0	406	2,6	15	NMRV130	132S6	7434
45,0	541	1,9	20	NMRV130	132S6	8182
36,0	661	1,6	25	NMRV130	132S6	8814
30,0	754	1,6	30	NMRV130	132S6	9366
22,5	968	1,1	40	NMRV130	132S6	10309
28,0	788	1,8	50	NMRV150	100LB4	13103
23,3	909	1,4	60	NMRV150	100LB4	13924
17,5	1130	1,0	80	NMRV150	100LB4	15325
14,0	1330	0,8	100	NMRV150	100LB4	16508



### 4,00 kW

n2 [1/min]	M2 [Nm]	f.s.	i			Fr [N]
373,3	93	1,4	7,5	NMRV075	112M2	2210
280,0	123	1,2	10	NMRV075	112M2	2433
186,7	182	1,0	7,5	NMRV075	112M4	2785
140,0	240	0,8	10	NMRV075	112M4	3065
373,3	94	2,2	7,5	NMRV090	112M2	2446
280,0	123	1,9	10	NMRV090	112M2	2692
186,7	184	1,7	7,5	NMRV090	112M4	3081
140,0	243	1,4	10	NMRV090	112M4	3391
93,3	356	1,1	15	NMRV090	112M4	3882
70,0	464	0,8	20	NMRV090	112M4	4273
140,0	243	2,4	10	NMRV105	112M4	4285
93,3	356	1,7	15	NMRV105	112M4	4905
70,0	469	1,3	20	NMRV105	112M4	5399
56,0	580	1,0	25	NMRV105	112M4	5816
46,7	655	1,0	30	NMRV105	112M4	6181
120,0	283	2,2	7,5	NMRV105	132L6	4511
90,0	374	1,8	10	NMRV105	132L6	4965
60,0	548	1,3	15	NMRV105	132L6	5684
140,0	243	2,5	10	NMRV110	112M4	4285
93,3	356	1,8	15	NMRV110	112M4	4905
70,0	469	1,4	20	NMRV110	112M4	5399
56,0	580	1,2	25	NMRV110	112M4	5816
46,7	655	1,1	30	NMRV110	112M4	6181
120,0	283	2,3	7,5	NMRV110	132L6	4511
90,0	374	1,9	10	NMRV110	132L6	4965
60,0	548	1,4	15	NMRV110	132L6	5684
56,0	580	1,6	25	NMRV130	112M4	7607
46,7	663	1,6	30	NMRV130	112M4	8084
35,0	862	1,2	40	NMRV130	112M4	8897
28,0	1037	0,9	50	NMRV130	112M4	9584
23,3	1195	0,8	60	NMRV130	112M4	10185
120,0	287	3,1	7,5	NMRV130	132L6	5901
90,0	374	2,6	10	NMRV130	132L6	6494
60,0	541	2,0	15	NMRV130	132L6	7434
45,0	722	1,4	20	NMRV130	132L6	8182
36,0	881	1,2	25	NMRV130	132L6	8814
28,0	1051	1,3	50	NMRV150	112M4	13103
23,3	1211	1,0	60	NMRV150	112M4	13924
17,5	1506	0,8	80	NMRV150	112M4	15325



### 4,80 kW

n2 [1/min]	M2 [Nm]	f.s.	i			Fr [N]
186,7	221	1,4	7,5	NMRV090	112MS4	3081
140,0	291	1,2	10	NMRV090	112MS4	3391
93,3	427	0,9	15	NMRV090	112MS4	3882
186,7	221	2,4	7,5	NMRV105	112MS4	3893
140,0	291	2,0	10	NMRV105	112MS4	4285
93,3	427	1,4	15	NMRV105	112MS4	4905
70,0	563	1,1	20	NMRV105	112MS4	5399
56,0	696	0,8	25	NMRV105	112MS4	5816
186,7	221	2,5	7,5	NMRV110	112MS4	3893
140,0	291	2,1	10	NMRV110	112MS4	4285
93,3	427	1,5	15	NMRV110	112MS4	4905
70,0	563	1,1	20	NMRV110	112MS4	5399
56,0	696	1,0	25	NMRV110	112MS4	5816
56,0	696	1,3	25	NMRV130	112MS4	7607
46,7	796	1,3	30	NMRV130	112MS4	8084
35,0	1035	1,0	40	NMRV130	112MS4	8897
28,0	1244	0,8	50	NMRV130	112MS4	9584
28,0	1261	1,1	50	NMRV150	112MS4	13103
23,3	1454	0,9	60	NMRV150	112MS4	13924



### 5,50 kW

n2 [1/min]	M2 [Nm]	f.s.	i			Fr [N]
186,7	253	2,1	7,5	NMRV105	132S4	3893
140,0	334	1,7	10	NMRV105	132S4	4285
93,3	490	1,2	15	NMRV105	132S4	4905
70,0	645	1,0	20	NMRV105	132S4	5399
186,7	253	2,2	7,5	NMRV110	132S4	3893
140,0	334	1,8	10	NMRV110	132S4	4285
93,3	490	1,3	15	NMRV110	132S4	4905
70,0	645	1,0	20	NMRV110	132S4	5399
140,0	334	2,5	10	NMRV130	132S4	5605
93,3	490	1,9	15	NMRV130	132S4	6416
70,0	653	1,4	20	NMRV130	132S4	7062
56,0	797	1,2	25	NMRV130	132S4	7607
46,7	912	1,1	30	NMRV130	132S4	8084
35,0	1186	0,9	40	NMRV130	132S4	8897
70,0	653	2,0	20	NMRV150	132S4	9654
56,0	797	1,5	25	NMRV150	132S4	10400
46,7	945	1,3	30	NMRV150	132S4	11051
35,0	1186	1,3	40	NMRV150	132S4	12163
28,0	1444	1,0	50	NMRV150	132S4	13103
23,3	1666	0,8	60	NMRV150	132S4	13924



### 7,50 kW

n2 [1/min]	M2 [Nm]	f.s.	i			Fr [N]
186,7	345	1,5	7,5	NMRV105	132L4	3893
140,0	455	1,3	10	NMRV105	132L4	4285
93,3	668	0,9	15	NMRV105	132L4	4905
186,7	345	1,6	7,5	NMRV110	132L4	3893
140,0	455	1,3	10	NMRV110	132L4	4285
93,3	668	1,0	15	NMRV110	132L4	4905



## 7,50 kW

n2 [1/min]	M2 [Nm]	f.s.	i			Fr [N]
186,7	349	2,1	7,5	NMRV130	132L4	5092
140,0	455	1,8	10	NMRV130	132L4	5605
93,3	668	1,4	15	NMRV130	132L4	6416
70,0	890	1,0	20	NMRV130	132L4	7062
56,0	1087	0,9	25	NMRV130	132L4	7607
46,7	1243	0,8	30	NMRV130	132L4	8084
35,0	1617	0,6	40	NMRV130	132L4	8897
70,0	890	1,5	20	NMRV150	132L4	9654
56,0	1087	1,1	25	NMRV150	132L4	10400
46,7	1289	0,9	30	NMRV150	132L4	11051
35,0	1617	1,0	40	NMRV150	132L4	12163



## 9,20 kW

n2 [1/min]	M2 [Nm]	f.s.	i			Fr [N]
186,7	424	1,3	7,5	NMRV110	132M4	3893
186,7	428	1,8	7,5	NMRV130	132M4	5092
140,0	559	1,5	10	NMRV130	132M4	5605
93,3	819	1,1	15	NMRV130	132M4	6416
70,0	1092	0,8	20	NMRV130	132M4	7062
56,0	1334	0,7	25	NMRV130	132M4	7607
70,0	1092	1,2	20	NMRV150	132M4	9654
56,0	1334	0,9	25	NMRV150	132M4	10400
46,7	1581	0,8	30	NMRV150	132M4	11051
35,0	1983	0,8	40	NMRV150	132M4	12163

## 11,00 kW

n2 [1/min]	M2 [Nm]	f.s.	i			Fr [N]
186,7	512	2,3	7,5	NMRV150	160M4	6962
140,0	675	1,8	10	NMRV150	160M4	7663
93,3	990	1,3	15	NMRV150	160M4	8771
70,0	1306	1,0	20	NMRV150	160M4	9654
56,0	1595	0,8	25	NMRV150	160M4	10400

## 15,00 kW

n2 [1/min]	M2 [Nm]	f.s.	i			Fr [N]
186,7	698	1,7	7,5	NMRV150	160L4	6962
140,0	921	1,3	10	NMRV150	160L4	7663
93,3	1351	0,9	15	NMRV150	160L4	8771
70,0	1780	0,7	20	NMRV150	160L4	9654